

Data sheet | Item number: 769-668/003-000

THT male header; 1.0 x 1.0 mm solder pin; angled; clamping collar; Pin spacing 5 mm; 8-pole

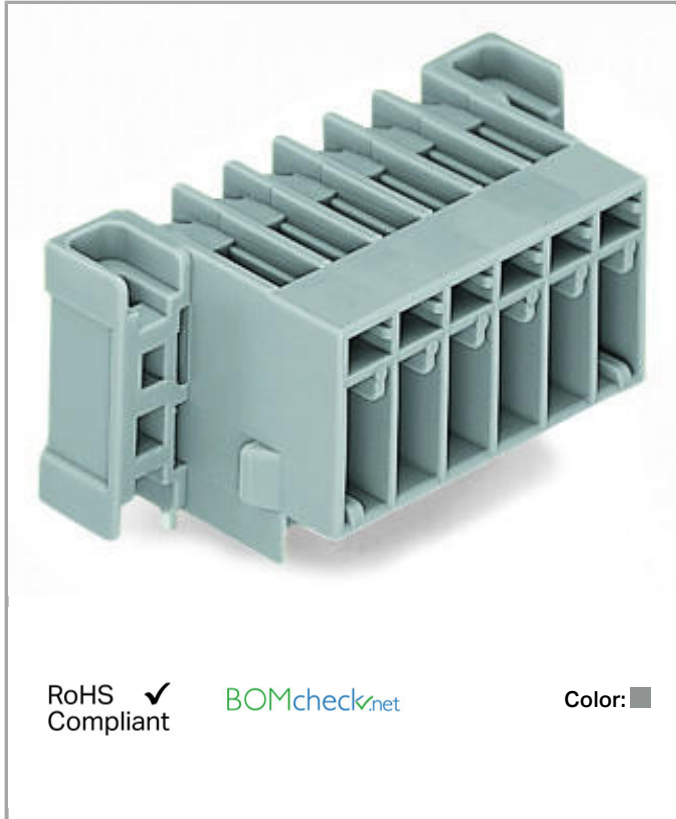

769-668_003-000



RoHS Compliant

[BOMcheck.net](https://www.bomcheck.net)

Color:

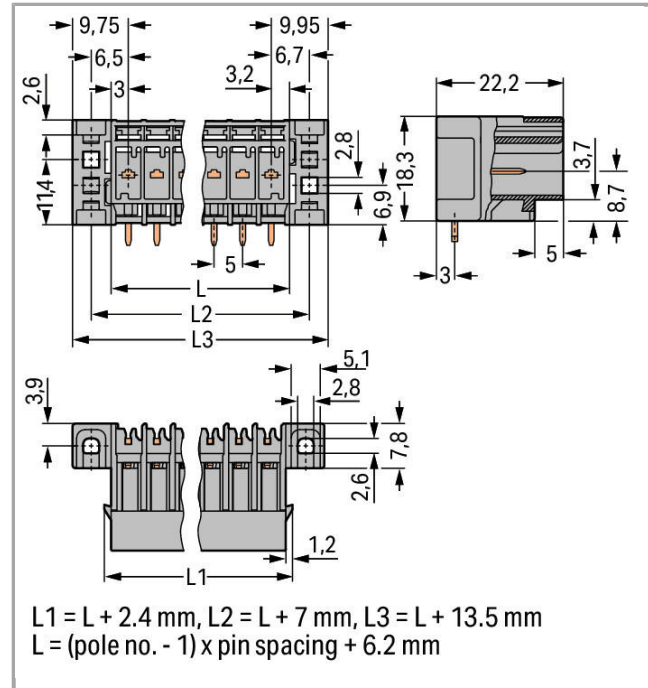

Data

Electrical data

Ratings per IEC/EN 60664-1

Rated voltage (III / 3)	250 V
Rated impulse voltage (III / 3)	4 kV
Rated voltage (III / 2)	500 V
Rated impulse voltage (III / 2)	4 kV
Rated current	32 A

Connection data

No. of poles	8
Total number of potentials	8
Number of levels	1

Geometrical Data

Pin spacing	5 mm / 0.197 inch
Width	54.7 mm / 2.154 inch
Height from the surface	18.3 mm / 0.72 inch
Depth	22.2 mm / 0.874 inch

Mechanical data

Mounting type	Mounting flange
---------------	-----------------

Plug connection

Contact type (pluggable connector)	Male connector/plug
Connector connection type	for PCBs
Mismating protection	No
Mating direction to the PCB	0°

PCB contact

PCB contact	THT
-------------	-----

Material Data

Color	gray
Insulating material	Polyamide 66 (PA 66)
Fire load	0.198 MJ
Weight	9.512 g

Commercial data

Product Group	18 (X-COM-System)
Country of origin	PL
GTIN	4044918396875
Customs Tariff No.	85366990990

Approvals / Certificates

Country specific Approvals

Logo	Approval	Additional Approval Text	Certificate name
	CCA DEKRA Certification B.V.	EN 60947	NTR NL- 7626
	CCA	EN 61984	2190419.02

DEKRA Certification B.V.



CCA DEKRA Certification B.V.	IEC 61984	NL-47799
---------------------------------	-----------	----------



CSA DEKRA Certification B.V.	C22.2 No. 158	1101144
---------------------------------	---------------	---------



KEMA/KEUR DEKRA Certification B.V.	EN 60947	2190419.01
---------------------------------------	----------	------------

UL-Approvals



Logo	Approval	Additional Approval Text	Certificate name
	UR Underwriters Laboratories Inc.	UL 1059	31.07.2019- E45172















Compatible products















Marking accessories















	Item no.: 210-831 Marking strips; on reel; 2.3 mm wide; plain; Self-adhesive	210-831
	Item no.: 210-832 Marking strips; on reel; 3 mm wide; plain; Self-adhesive	210-832
	Item no.: 210-833 Marking strips; on reel; 6 mm wide; plain; Self-adhesive	210-833
	Item no.: 210-834 Marking strips; on reel; 5 mm wide; plain; Self-adhesive	210-834















Female plug

















	Item no.: 769-101 1-conductor female plug; 4 mm ² ; 1-pole	769-101
	Item no.: 769-102 1-conductor female plug; 4 mm ² ; 2-pole	769-102
	Item no.: 769-102/000-036 1-conductor female plug; 4 mm ² ; 2-pole	769-102 /000-036

















	Item no.: 769-102/000-037 1-conductor female plug; 4 mm²; 2-pole	/000-037	769-102
	Item no.: 769-103 1-conductor female plug; 4 mm²; 3-pole		769-103
	Item no.: 769-103/000-036 1-conductor female plug; 4 mm²; 3-pole	/000-036	769-103
	Item no.: 769-103/000-037 1-conductor female plug; 4 mm²; 3-pole	/000-037	769-103
	Item no.: 769-103/000-038 1-conductor female plug; 4 mm²; 3-pole	/000-038	769-103
	Item no.: 769-103/000-039 1-conductor female plug; 4 mm²; 3-pole	/000-039	769-103
	Item no.: 769-104 1-conductor female plug; 4 mm²; 4-pole		769-104
	Item no.: 769-104/000-036 1-conductor female plug; 4 mm²; 4-pole	/000-036	769-104
	Item no.: 769-104/000-037 1-conductor female plug; 4 mm²; 4-pole	/000-037	769-104
	Item no.: 769-104/000-038 1-conductor female plug; 4 mm²; 4-pole	/000-038	769-104
	Item no.: 769-104/000-039 1-conductor female plug; 4 mm²; 4-pole	/000-039	769-104
	Item no.: 769-105 1-conductor female plug; 4 mm²; 5-pole		769-105
	Item no.: 769-105/000-036 1-conductor female plug; 4 mm²; 5-pole	/000-036	769-105
	Item no.: 769-105/000-037 1-conductor female plug; 4 mm²; 5-pole	/000-037	769-105
	Item no.: 769-105/000-038 1-conductor female plug; 4 mm²; 5-pole	/000-038	769-105

	Item no.: 769-105/000-039 1-conductor female plug; 4 mm ² ; 5-pole		769-105
		/000-039	
	Item no.: 769-106 1-conductor female plug; 4 mm ² ; 6-pole		769-106
	Item no.: 769-106/000-006 1-conductor female plug; 4 mm ² ; 6-pole		769-106
		/000-006	
	Item no.: 769-106/000-036 1-conductor female plug; 4 mm ² ; 6-pole		769-106
		/000-036	
	Item no.: 769-106/000-037 1-conductor female plug; 4 mm ² ; 6-pole		769-106
		/000-037	
	Item no.: 769-106/000-038 1-conductor female plug; 4 mm ² ; 6-pole		769-106
		/000-038	
	Item no.: 769-106/000-039 1-conductor female plug; 4 mm ² ; 6-pole		769-106
		/000-039	
	Item no.: 769-107 1-conductor female plug; 4 mm ² ; 7-pole		769-107
	Item no.: 769-107/000-036 1-conductor female plug; 4 mm ² ; 7-pole		769-107
		/000-036	
	Item no.: 769-107/000-037 1-conductor female plug; 4 mm ² ; 7-pole		769-107
		/000-037	
	Item no.: 769-107/000-038 1-conductor female plug; 4 mm ² ; 7-pole		769-107
		/000-038	
	Item no.: 769-107/000-039 1-conductor female plug; 4 mm ² ; 7-pole		769-107
		/000-039	
	Item no.: 769-108 1-conductor female plug; 4 mm ² ; 8-pole		769-108
	Item no.: 769-108/000-036 1-conductor female plug; 4 mm ² ; 8-pole		769-108
		/000-036	
	Item no.: 769-108/000-037 1-conductor female plug; 4 mm ² ; 8-pole		769-108
		/000-037	

	Item no.: 769-108/000-038 1-conductor female plug; 4 mm ² ; 8-pole	/000-038	769-108
	Item no.: 769-108/000-039 1-conductor female plug; 4 mm ² ; 8-pole	/000-039	769-108
	Item no.: 769-108/021-000 1-conductor female plug; Locking lever; 4 mm ² ; 8-pole	/021-000	769-108
	Item no.: 769-109 1-conductor female plug; 4 mm ² ; 9-pole		769-109
	Item no.: 769-109/000-036 1-conductor female plug; 4 mm ² ; 9-pole	/000-036	769-109
	Item no.: 769-109/000-037 1-conductor female plug; 4 mm ² ; 9-pole	/000-037	769-109
	Item no.: 769-109/000-038 1-conductor female plug; 4 mm ² ; 9-pole	/000-038	769-109
	Item no.: 769-109/000-039 1-conductor female plug; 4 mm ² ; 9-pole	/000-039	769-109
	Item no.: 769-110 1-conductor female plug; 4 mm ² ; 10-pole		769-110
	Item no.: 769-110/000-036 1-conductor female plug; 4 mm ² ; 10-pole	/000-036	769-110
	Item no.: 769-110/000-037 1-conductor female plug; 4 mm ² ; 10-pole	/000-037	769-110
	Item no.: 769-110/000-038 1-conductor female plug; 4 mm ² ; 10-pole	/000-038	769-110
	Item no.: 769-110/000-039 1-conductor female plug; 4 mm ² ; 10-pole	/000-039	769-110
	Item no.: 769-111 1-conductor female plug; 4 mm ² ; 11-pole		769-111
	Item no.: 769-111/000-036 1-conductor female plug; 4 mm ² ; 11-pole	/000-036	769-111

	Item no.: 769-111/000-037 1-conductor female plug; 4 mm²; 11-pole	769-111 /000-037
	Item no.: 769-111/000-038 1-conductor female plug; 4 mm²; 11-pole	769-111 /000-038
	Item no.: 769-111/000-039 1-conductor female plug; 4 mm²; 11-pole	769-111 /000-039
	Item no.: 769-112 1-conductor female plug; 4 mm²; 12-pole	769-112
	Item no.: 769-112/000-036 1-conductor female plug; 4 mm²; 12-pole	769-112 /000-036
	Item no.: 769-112/000-037 1-conductor female plug; 4 mm²; 12-pole	769-112 /000-037
	Item no.: 769-112/000-038 1-conductor female plug; 4 mm²; 12-pole	769-112 /000-038
	Item no.: 769-112/000-039 1-conductor female plug; 4 mm²; 12-pole	769-112 /000-039
	Item no.: 769-113 1-conductor female plug; 4 mm²; 13-pole	769-113
	Item no.: 769-113/000-036 1-conductor female plug; 4 mm²; 13-pole	769-113 /000-036
	Item no.: 769-113/000-037 1-conductor female plug; 4 mm²; 13-pole	769-113 /000-037
	Item no.: 769-113/000-038 1-conductor female plug; 4 mm²; 13-pole	769-113 /000-038
	Item no.: 769-113/000-039 1-conductor female plug; 4 mm²; 13-pole	769-113 /000-039
	Item no.: 769-114 1-conductor female plug; 4 mm²; 14-pole	769-114
	Item no.: 769-114/000-036 1-conductor female plug; 4 mm²; 14-pole	769-114 /000-036

	Item no.: 769-114/000-037 1-conductor female plug; 4 mm ² ; 14-pole	769-114 /000-037
	Item no.: 769-114/000-038 1-conductor female plug; 4 mm ² ; 14-pole	769-114 /000-038
	Item no.: 769-114/000-039 1-conductor female plug; 4 mm ² ; 14-pole	769-114 /000-039
	Item no.: 769-115 1-conductor female plug; 4 mm ² ; 15-pole	769-115
	Item no.: 769-115/000-036 1-conductor female plug; 4 mm ² ; 15-pole	769-115 /000-036
	Item no.: 769-115/000-037 1-conductor female plug; 4 mm ² ; 15-pole	769-115 /000-037
	Item no.: 769-115/000-038 1-conductor female plug; 4 mm ² ; 15-pole	769-115 /000-038
	Item no.: 769-115/000-039 1-conductor female plug; 4 mm ² ; 15-pole	769-115 /000-039
	Item no.: 769-121 2-conductor female connector; 4 mm ² ; 1-pole	769-121
	Item no.: 769-122 2-conductor female connector; 4 mm ² ; 2-pole	769-122
	Item no.: 769-123 2-conductor female connector; 4 mm ² ; 3-pole	769-123
	Item no.: 769-124 2-conductor female connector; 4 mm ² ; 4-pole	769-124
	Item no.: 769-125 2-conductor female connector; 4 mm ² ; 5-pole	769-125
	Item no.: 769-126 2-conductor female connector; 4 mm ² ; 6-pole	769-126
	Item no.: 769-127 2-conductor female connector; 4 mm ² ; 7-pole	769-127
	Item no.: 769-128 2-conductor female connector; 4 mm ² ; 8-pole	769-128
	Item no.: 769-129 2-conductor female connector; 4 mm ² ; 9-pole	769-129

	Item no.: 769-130 2-conductor female connector; 4 mm ² ; 10-pole	769-130
	Item no.: 769-131 2-conductor female connector; 4 mm ² ; 11-pole	769-131
	Item no.: 769-132 2-conductor female connector; 4 mm ² ; 12-pole	769-132
	Item no.: 769-133 2-conductor female connector; 4 mm ² ; 13-pole	769-133
	Item no.: 769-134 2-conductor female connector; 4 mm ² ; 14-pole	769-134
	Item no.: 769-135 2-conductor female connector; 4 mm ² ; 15-pole	769-135
Coding		
	Item no.: 769-435 Coding pin; for coding of female plugs; for carrier terminal blocks / male connectors	769-435
ferrule		
	Item no.: 216-101 Ferrule; Sleeve for 0.5 mm ² / AWG 22; uninsulated; electro-tin plated	216-101
	Item no.: 216-102 Ferrule; Sleeve for 0.75 mm ² / AWG 20; uninsulated; electro-tin plated	216-102
	Item no.: 216-103 Ferrule; Sleeve for 1 mm ² / AWG 18; uninsulated; electro-tin plated	216-103
	Item no.: 216-104 Ferrule; Sleeve for 1.5 mm ² / AWG 16; uninsulated; electro-tin plated	216-104
	Item no.: 216-201 Ferrule; Sleeve for 0.5 mm ² / 20 AWG; insulated; electro-tin plated	216-201
	Item no.: 216-202 Ferrule; Sleeve for 0.75 mm ² / 18 AWG; insulated; electro-tin plated	216-202
	Item no.: 216-203 Ferrule; Sleeve for 1 mm ² / AWG 18; insulated; electro-tin plated	216-203
	Item no.: 216-204 Ferrule; Sleeve for 1.5 mm ² / AWG 16; insulated; electro-tin plated	216-204
	Item no.: 216-206 Ferrule; Sleeve for 2.5 mm ² / AWG 14; insulated; electro-tin plated	216-206
	Item no.: 216-301 Ferrule; Sleeve for 0.25 mm ² / AWG 24; insulated; electro-tin plated	216-301
	Item no.: 216-302 Ferrule; Sleeve for 0.34 mm ² / 22 AWG; insulated; electro-tin plated	216-302



Downloads

Documentation

Bid Text

769-668/003-000		doc 25.6 kB	Download
-----------------	--	----------------	----------

Additional Information

Technical explanations	Apr 3, 2019	pdf 2.1 MB	Download
------------------------	-------------	---------------	----------

CAD/CAE - Smart Data

CAD data

3D Download 769-668/003-000		URL	Download
-----------------------------	--	-----	----------

Product family

X-COM

Show all products from the family

Subject to changes.
